

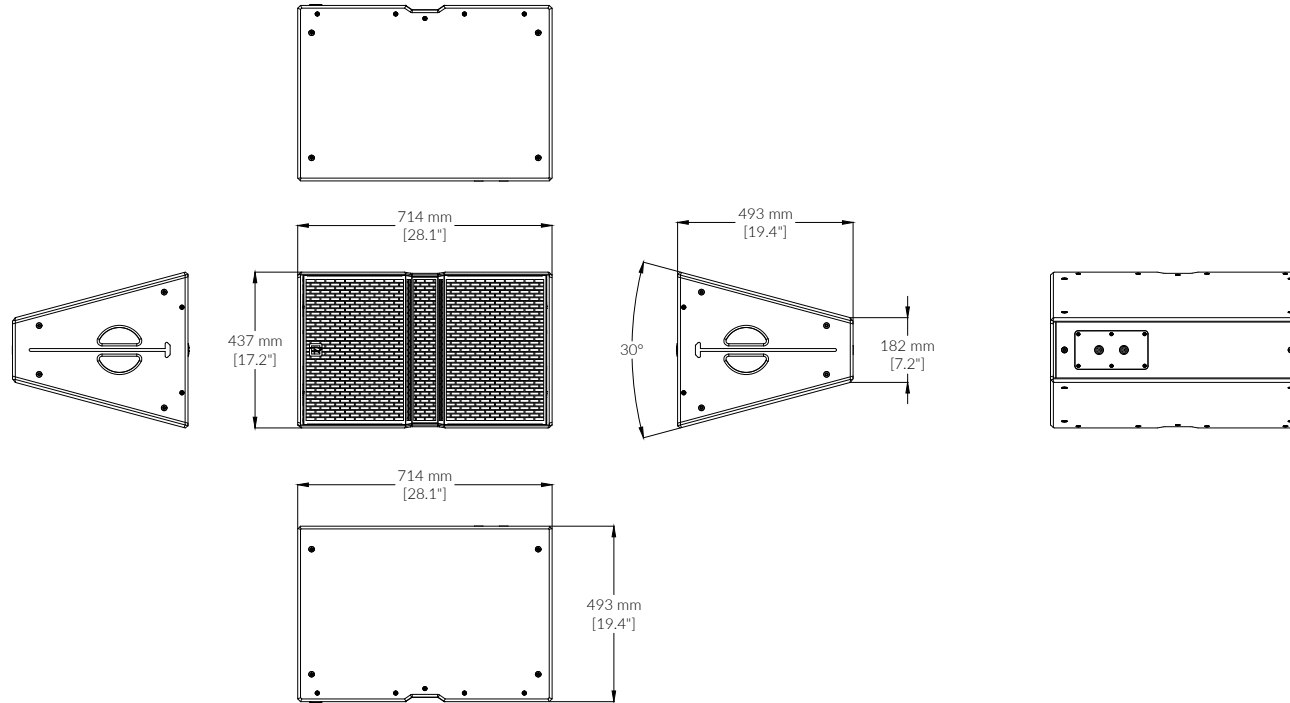

NO.	修改内容 Modification	日期 Date



受控正本 Original	受控副本 Copy	单位章 Stamp	核准 Approval		品名 & 型号 Name & Model	V30		图名 Title		
			审核 Audit		角度投影 Projection Angle		图号 File No.			
			制图 Drawer	2026-3-28	图框版本 Ver		单位 Unit	mm	比例 Scale	



NO.	修改内容 Modification	日期 Date

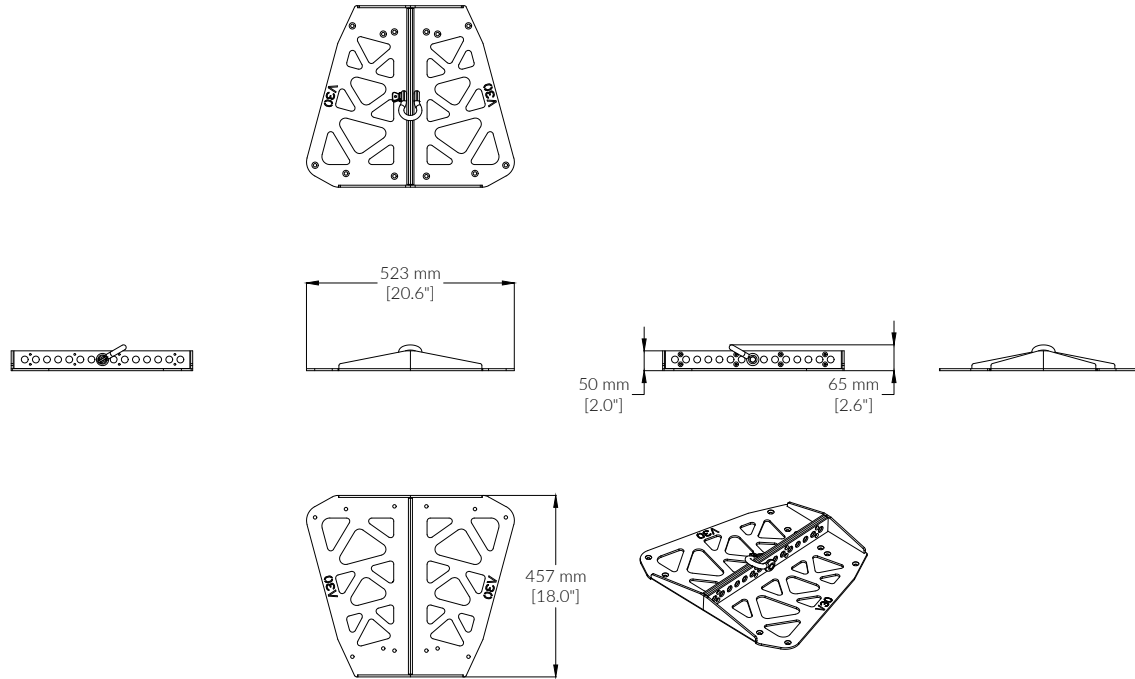

受控正本 Original	受控副本 Copy	单位章 Stamp	核准 Approval		品名 & 型号 Name & Model	V30水平吊架		图名 Title			
			审核 Audit			角度投影 Projection Angle		图号 File No.			
			制图 Drawer	2026-3-23		图框版本 Ver		单位 Unit	mm	比例 Scale	



NO.	修改内容 Modification	日期 Date

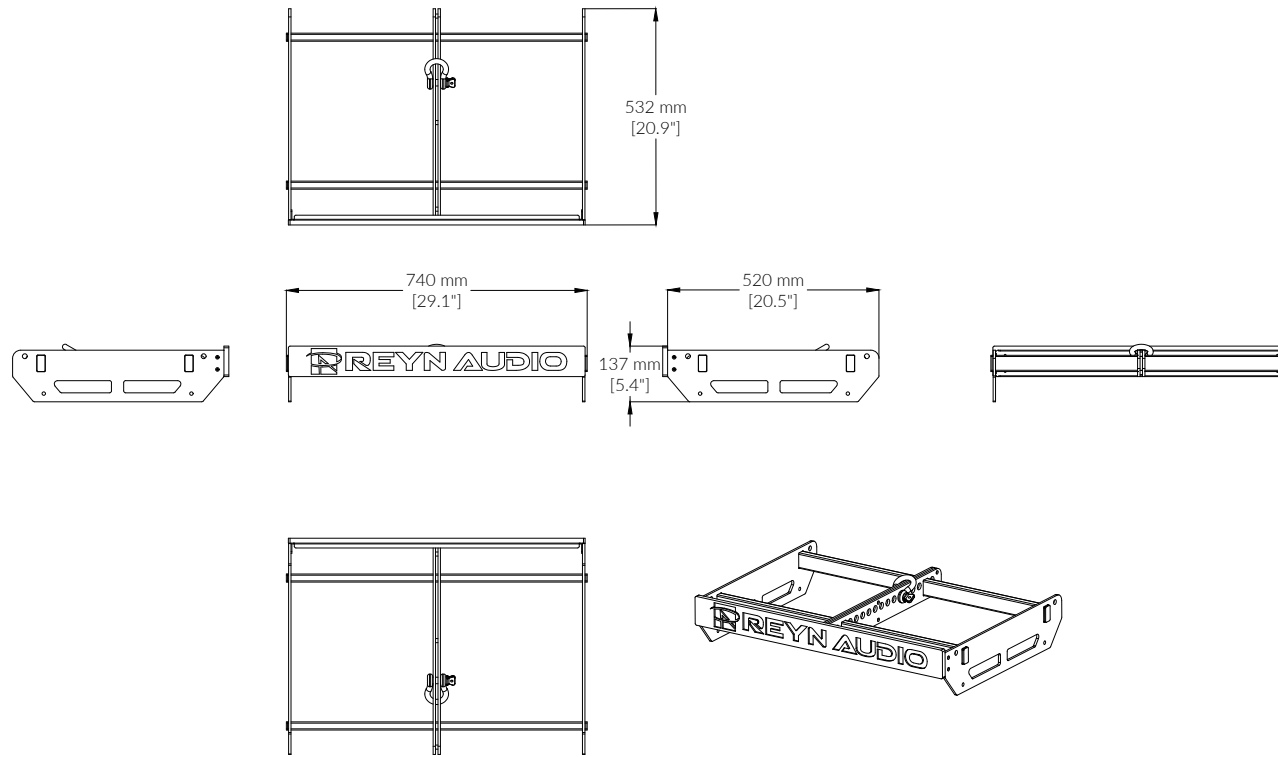

受控正本 Original	受控副本 Copy	单位章 Stamp	核准 Approval		品名 & 型号 Name & Model	V 吊架		图名 Title		
			审核 Audit		角度投影 Projection Angle		图号 File No.			
			制图 Drawer	2026-3-23	图框版本 Ver		单位 Unit	mm	比例 Scale	

NO.	修改内容 Modification	日期 Date

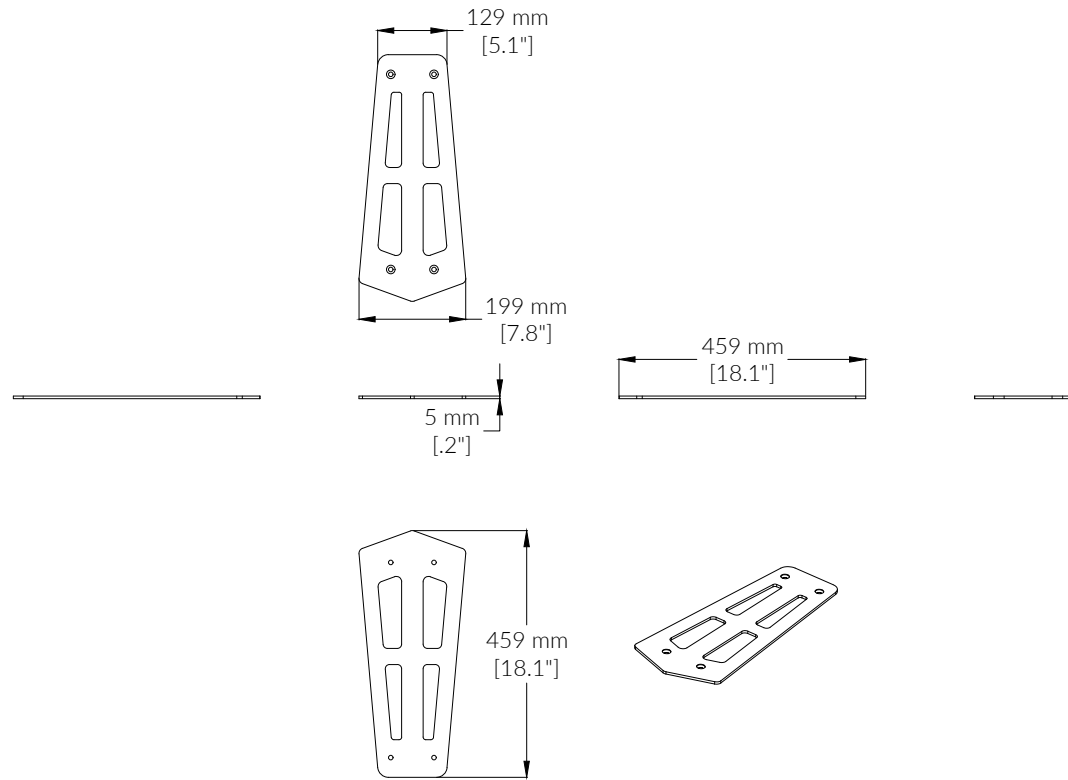

受控正本 Original	受控副本 Copy	单位章 Stamp	核准 Approval		品名 & 型号 Name & Model	V连接板		图名 Title				
			审核 Audit		角度投影 Projection Angle			图号 File No.				
			制图 Drawer	2026-3-23	图框版本 Ver		单位 Unit	mm	比例 Scale		共 1 页	第 1 页 Page